

Hall_1

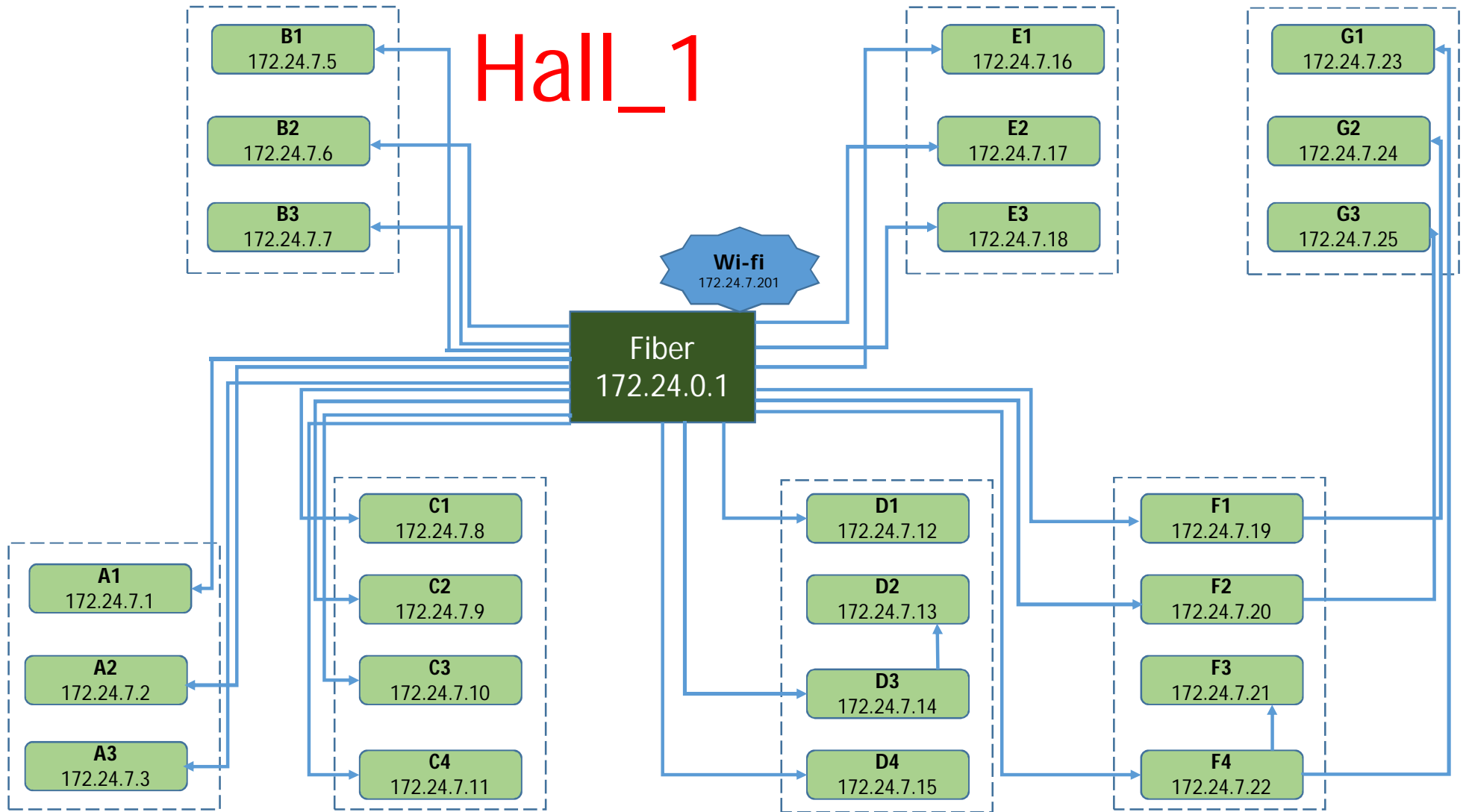

Hall_2

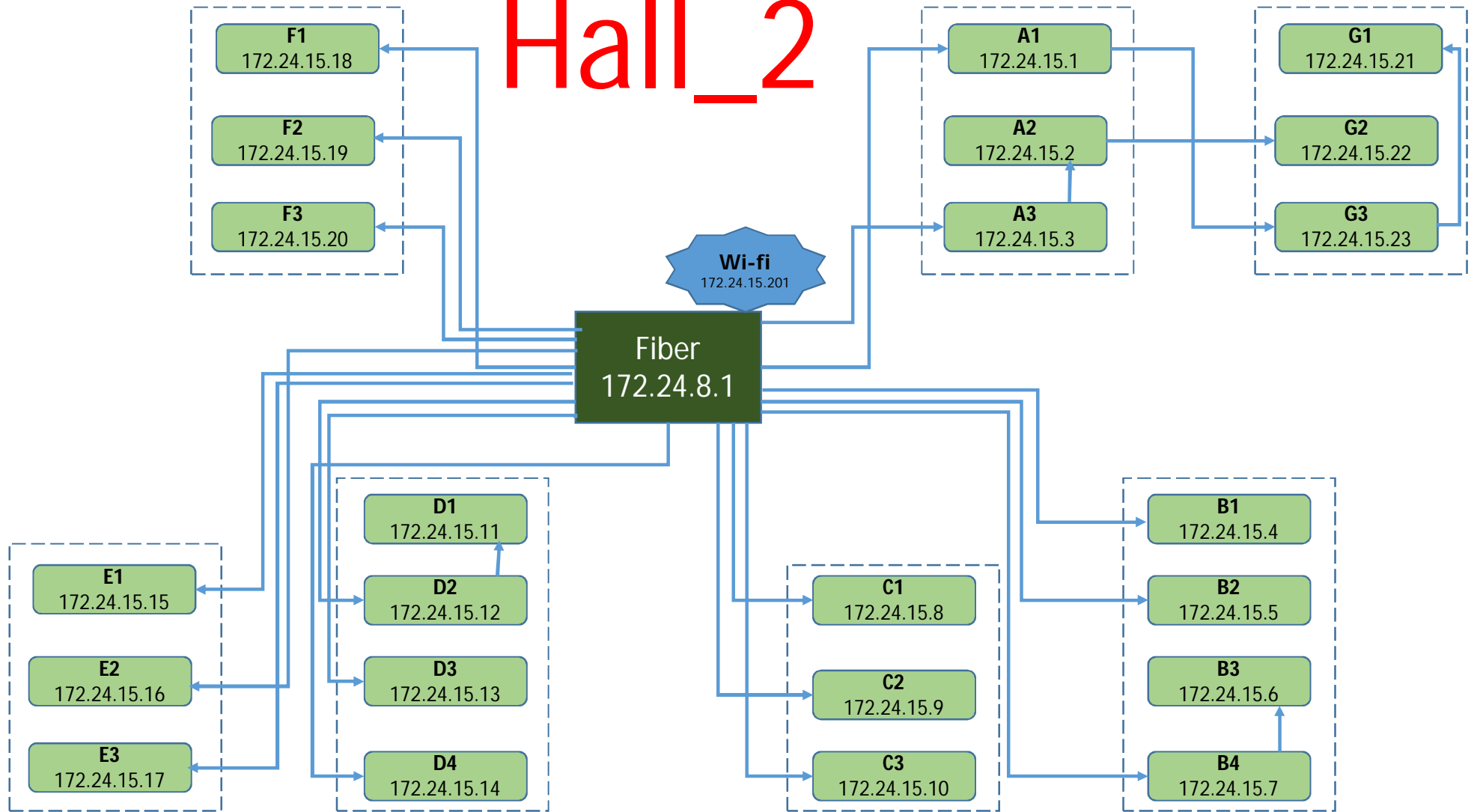

Hall_3

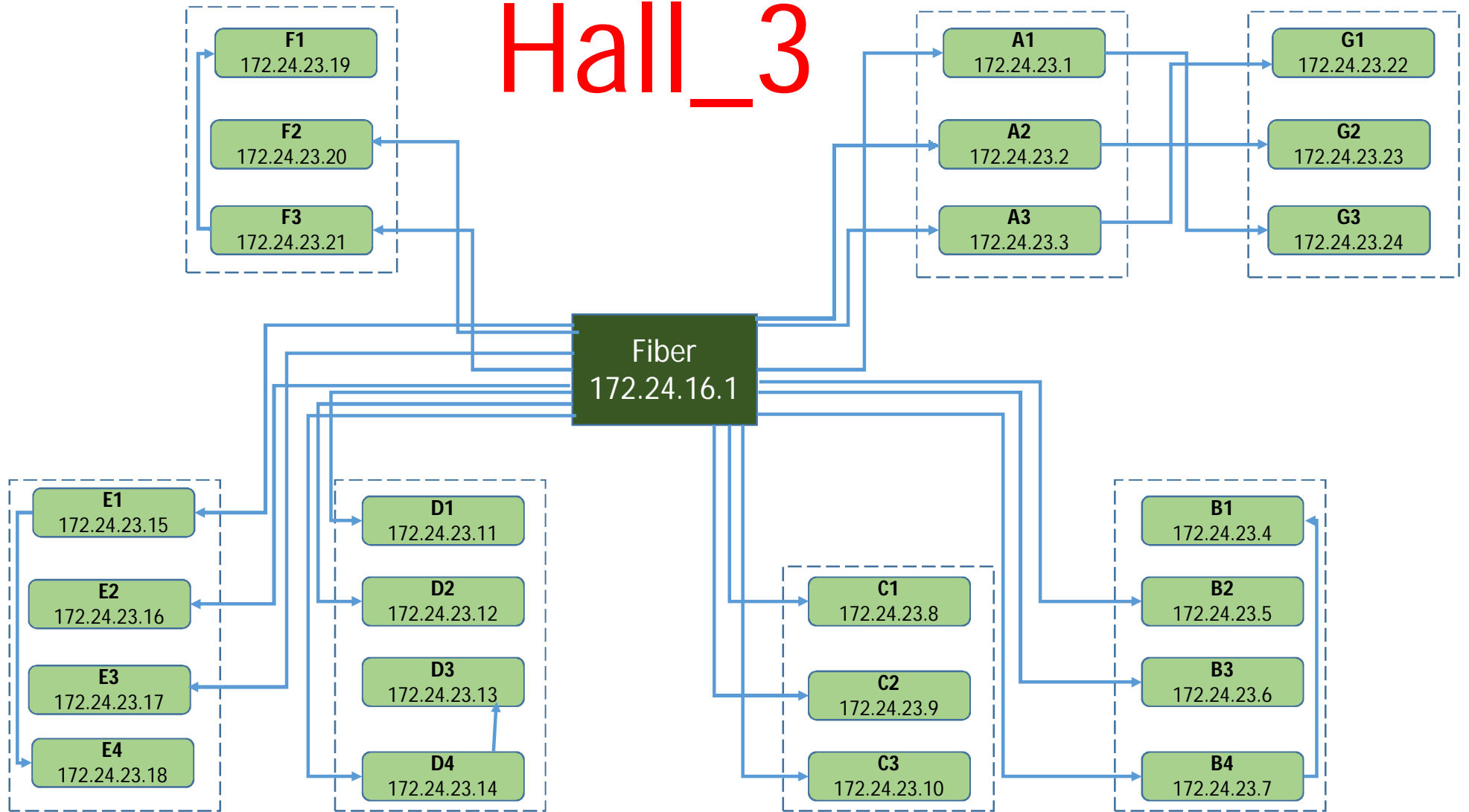

Hall_4

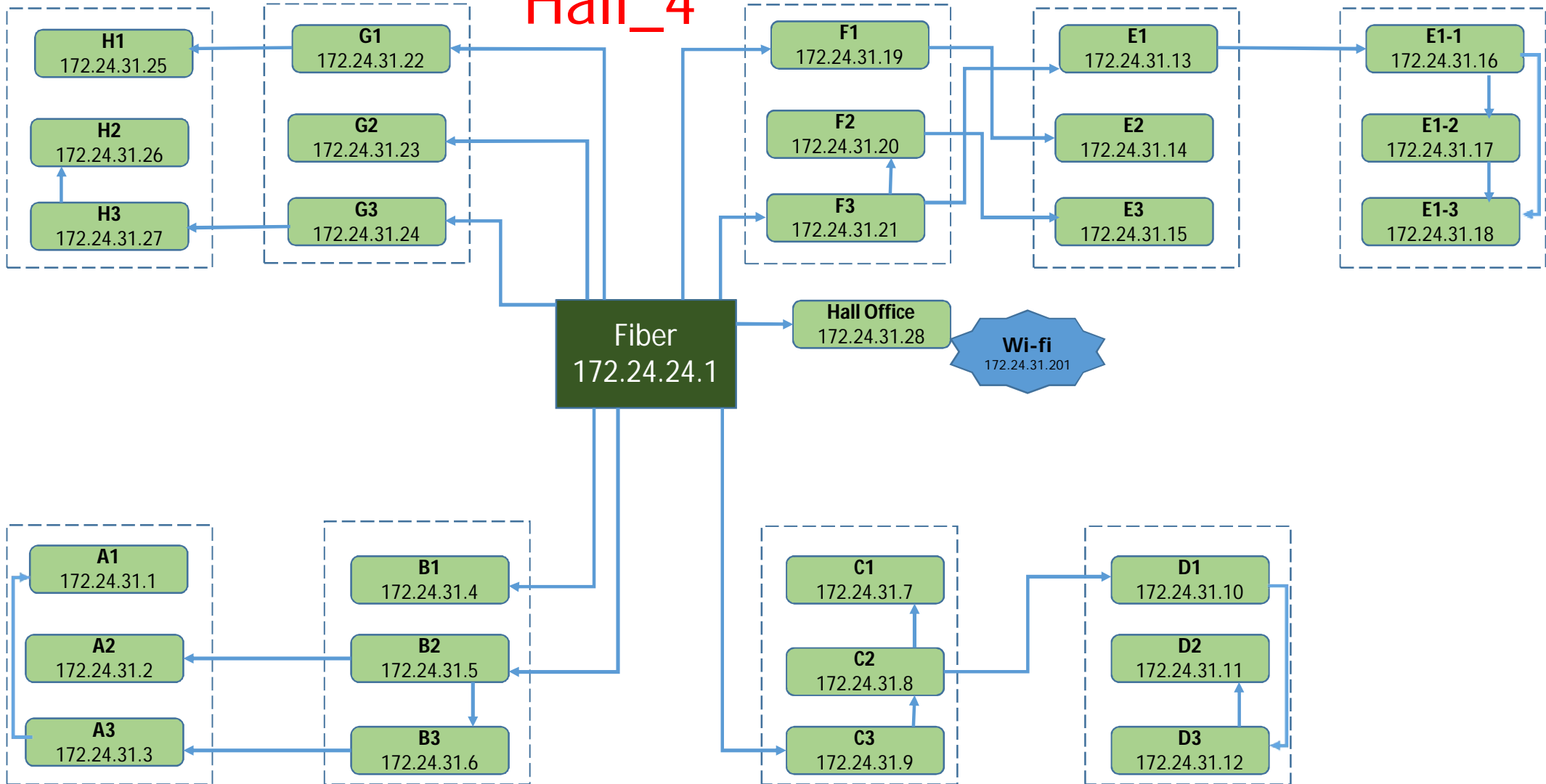

Hall_5

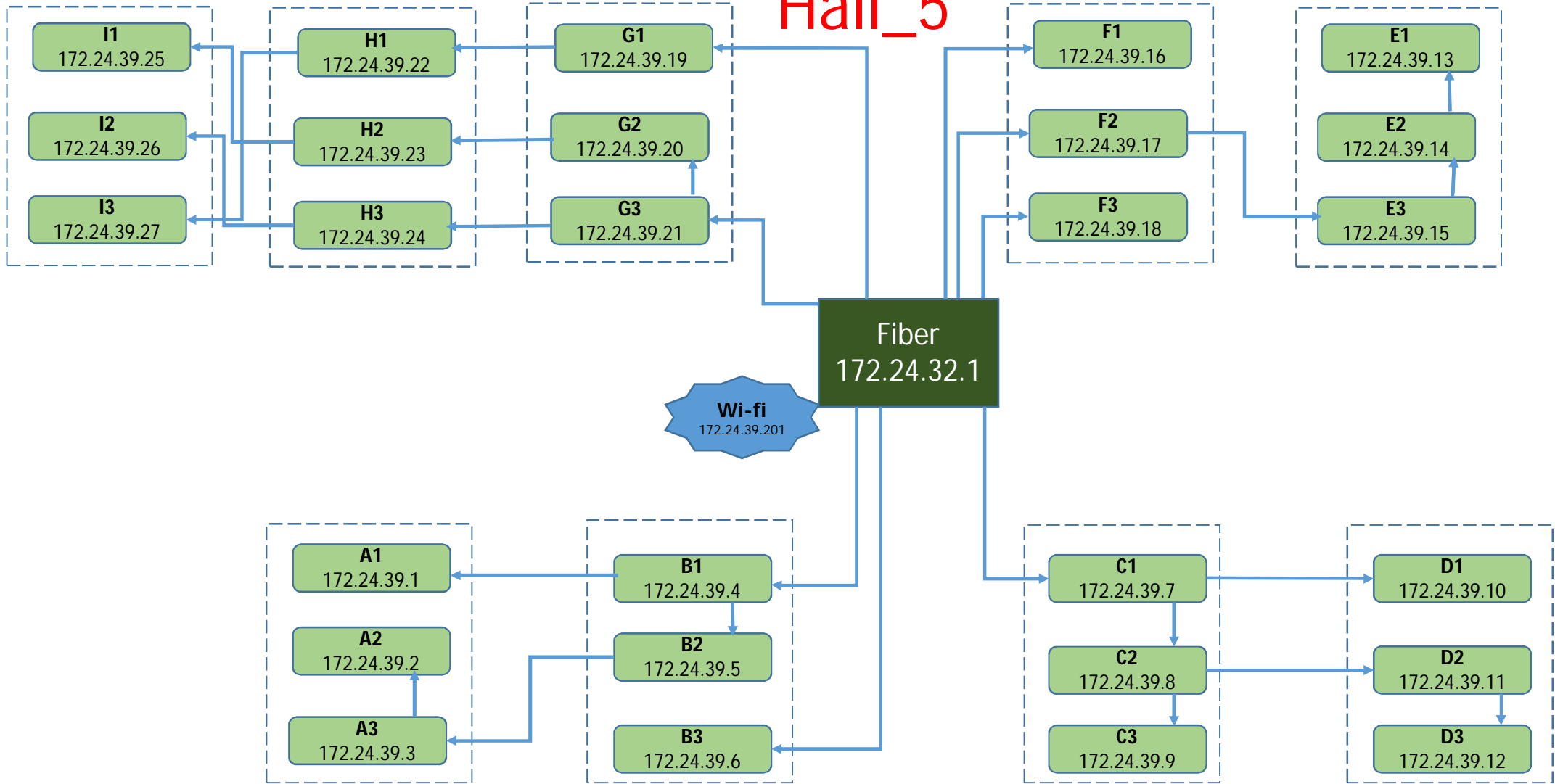

Hall_6 (A-B) Block

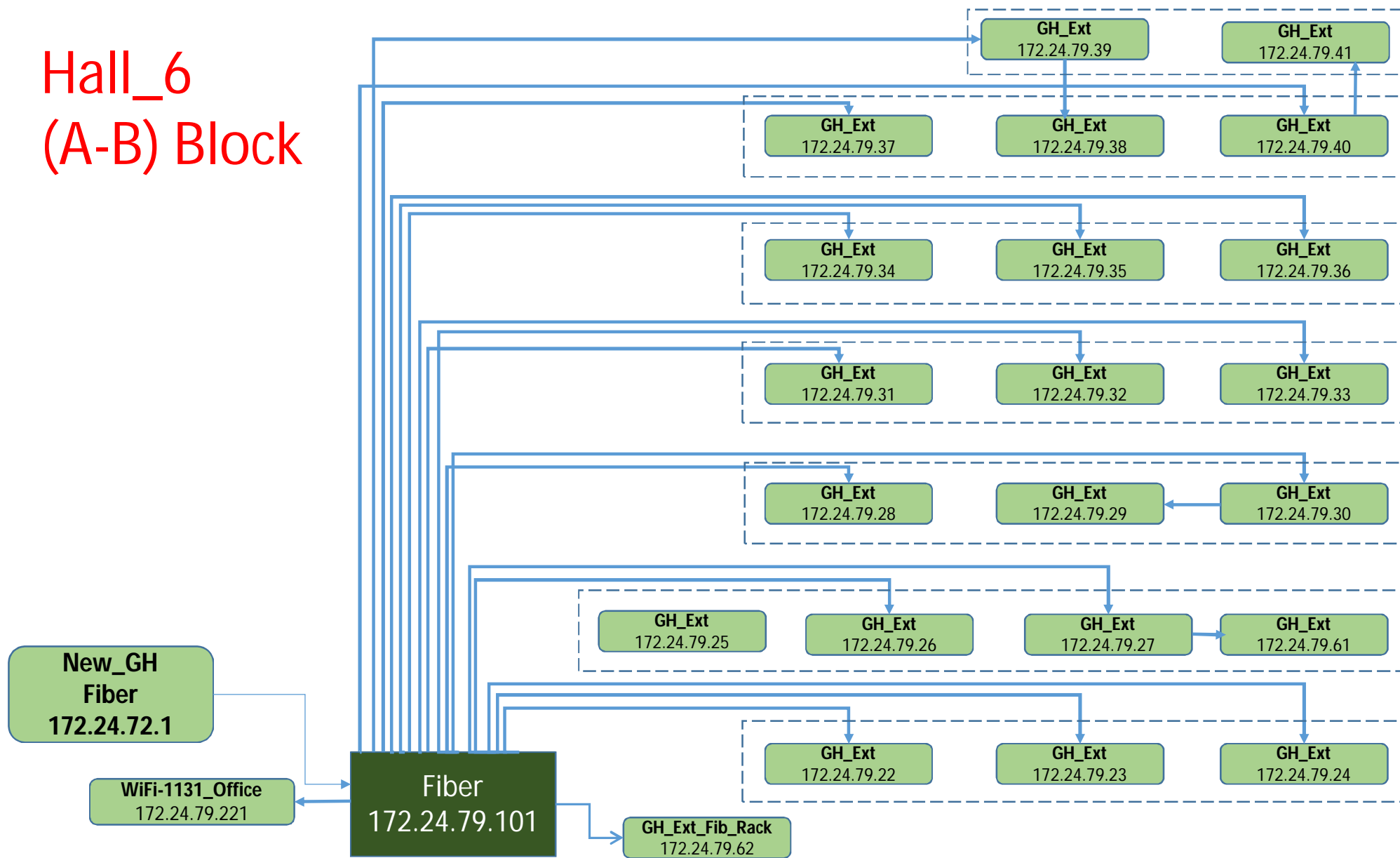

Hall_7

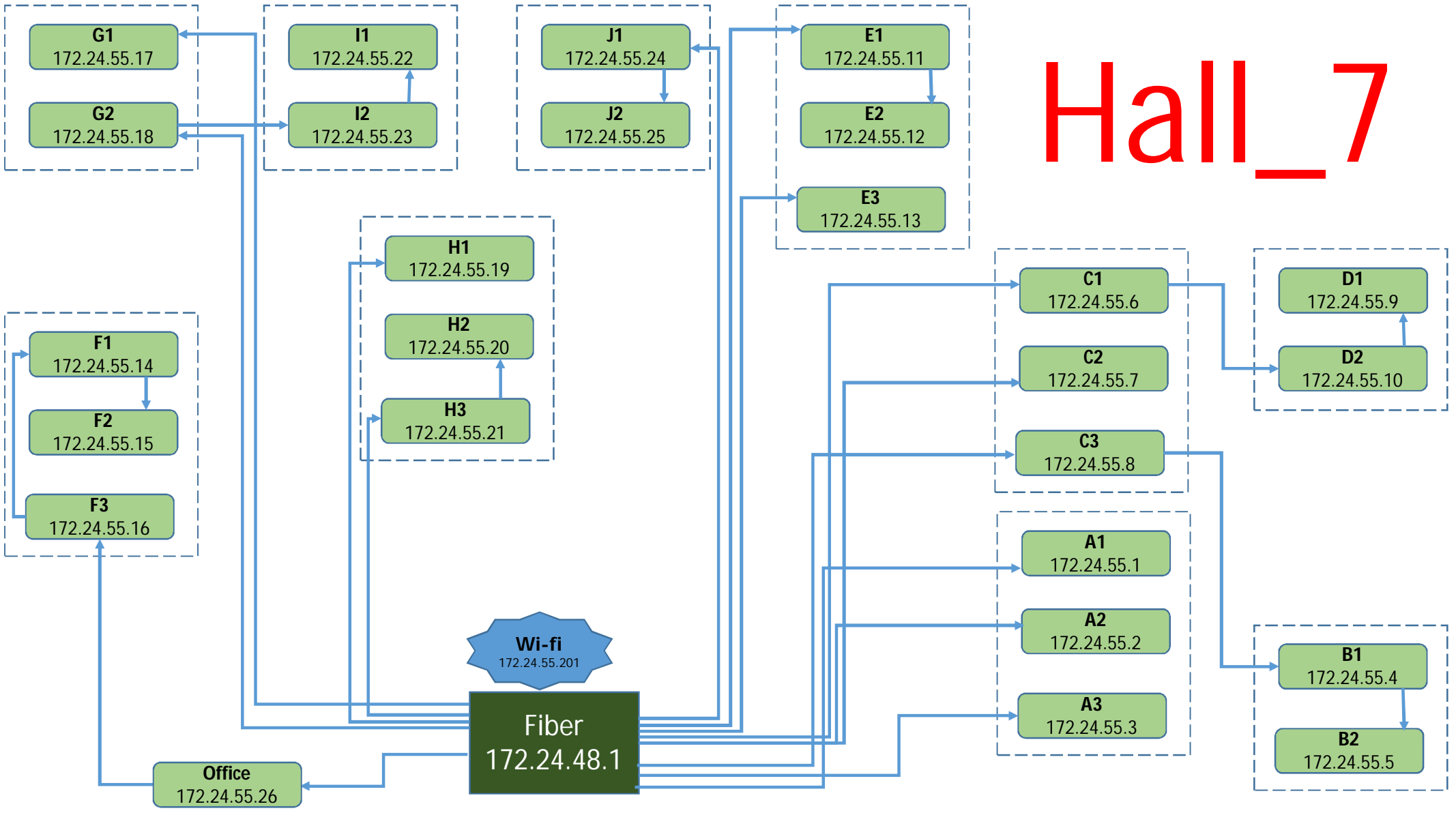

Hall_8

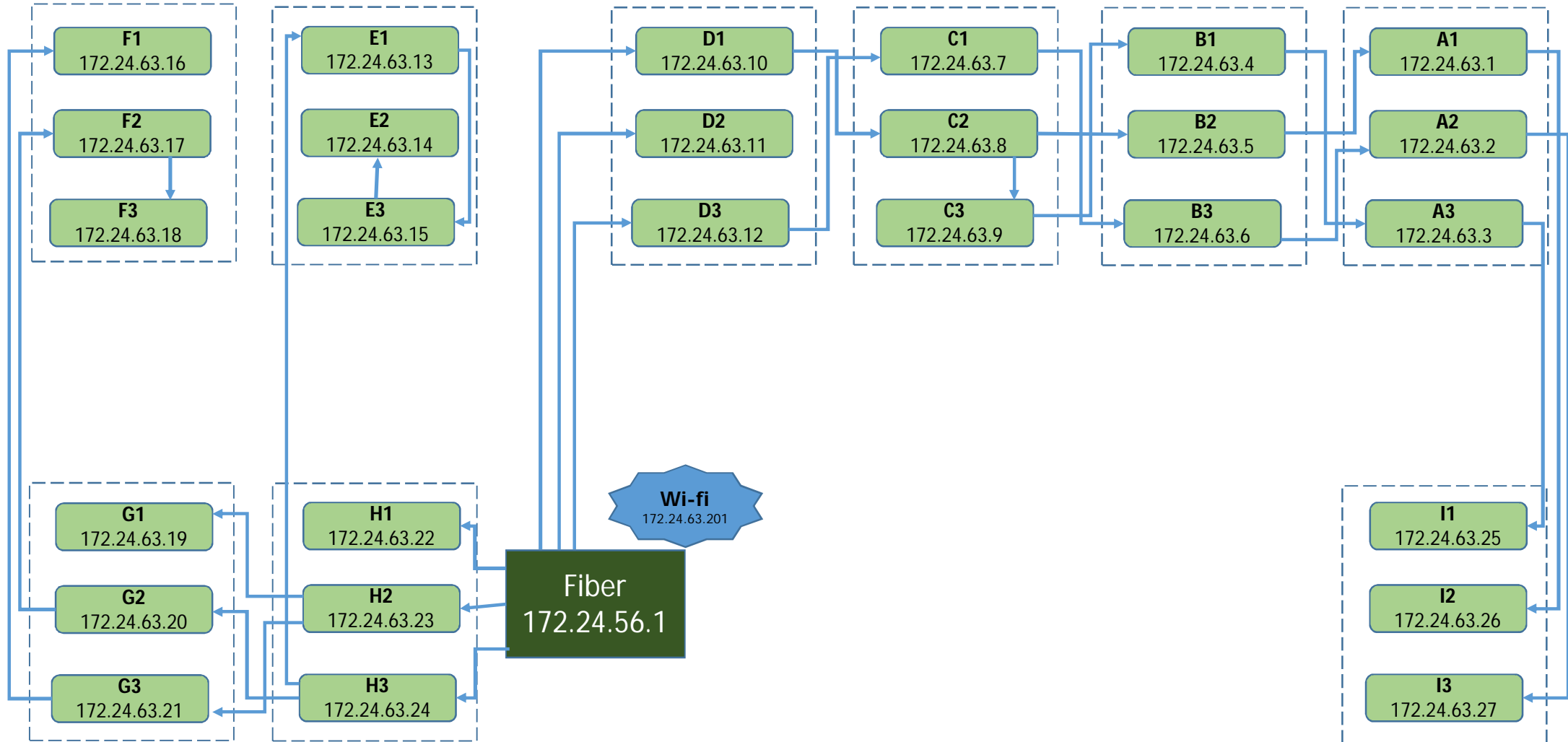

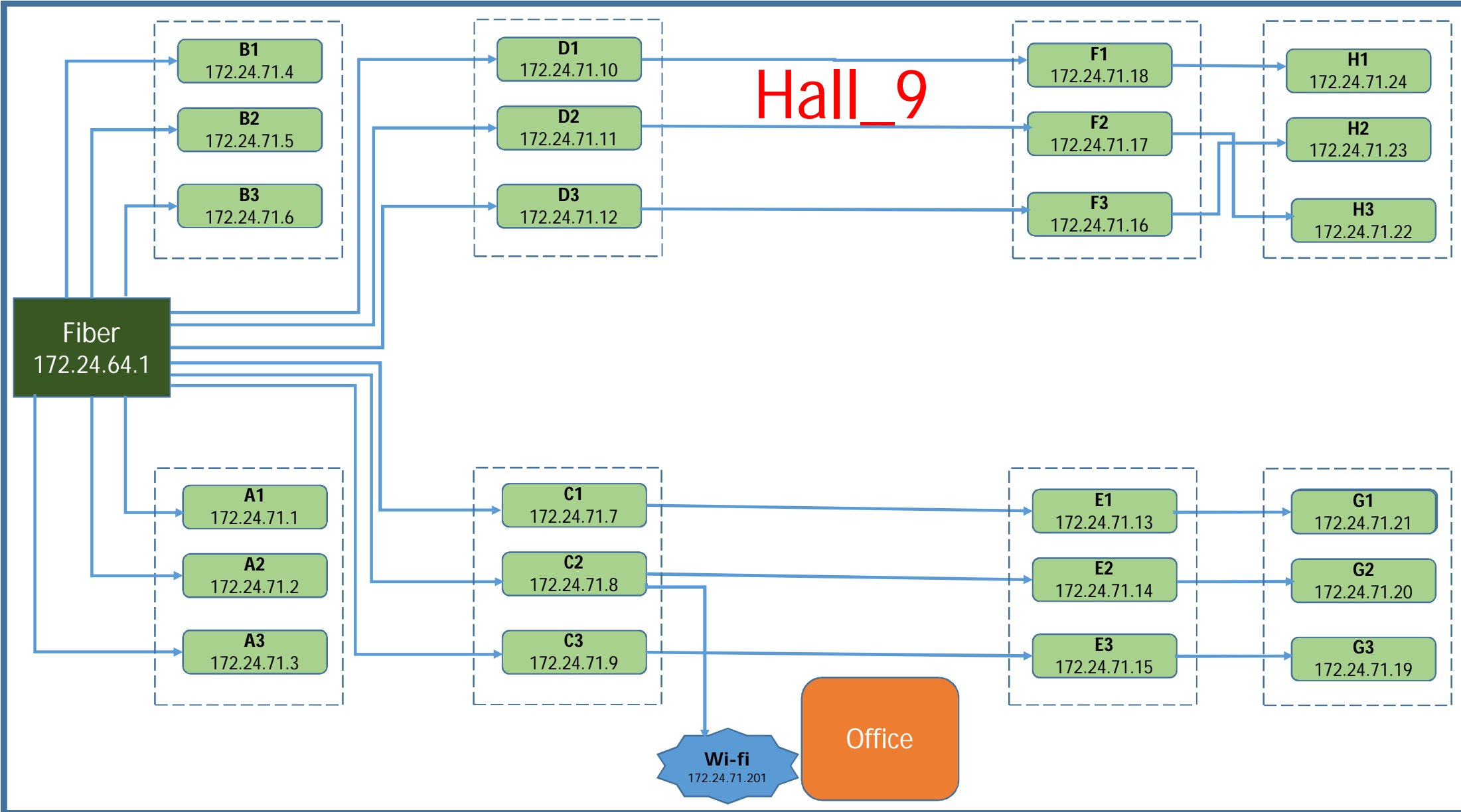

Hall_10

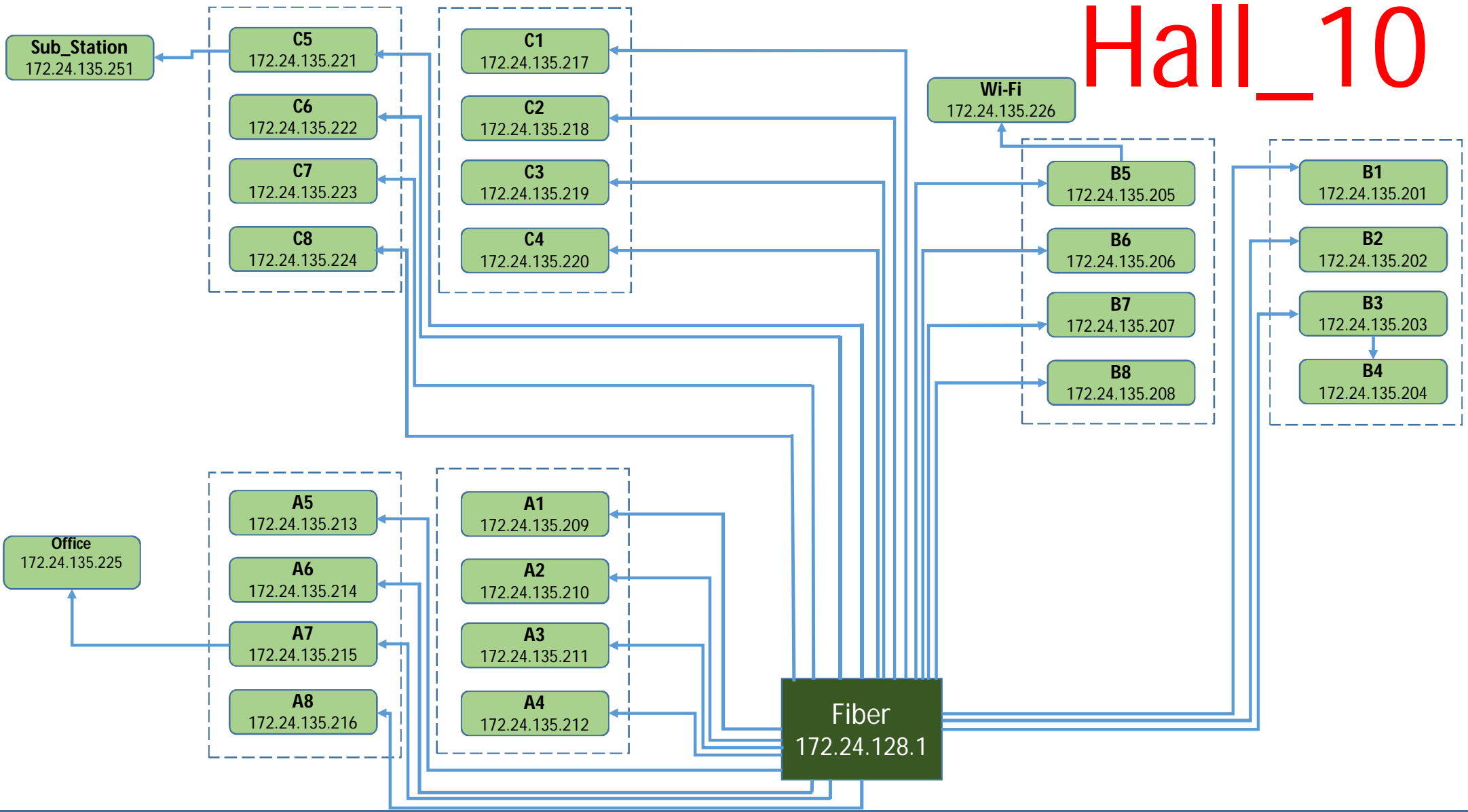

Hall_11

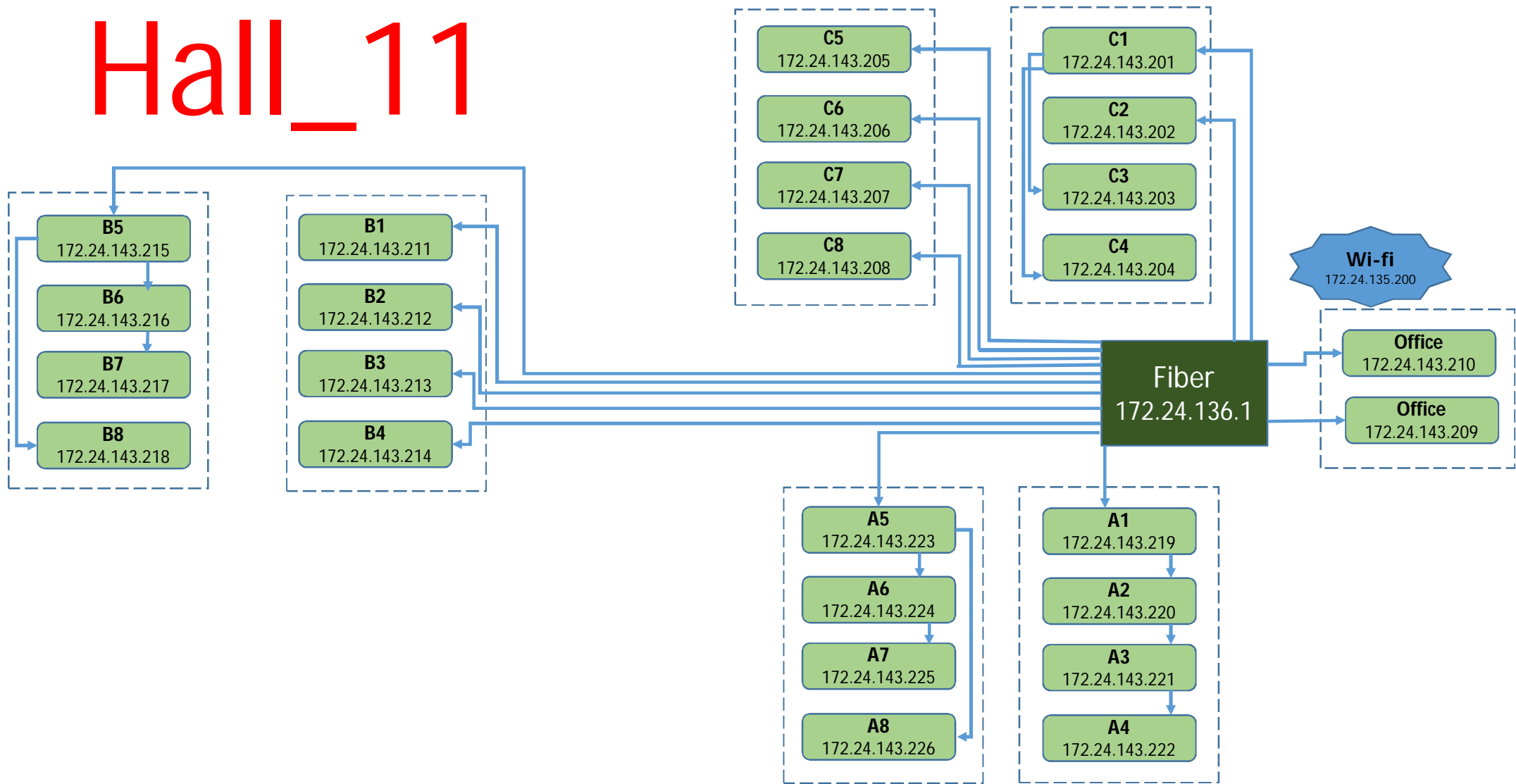

Hall-12

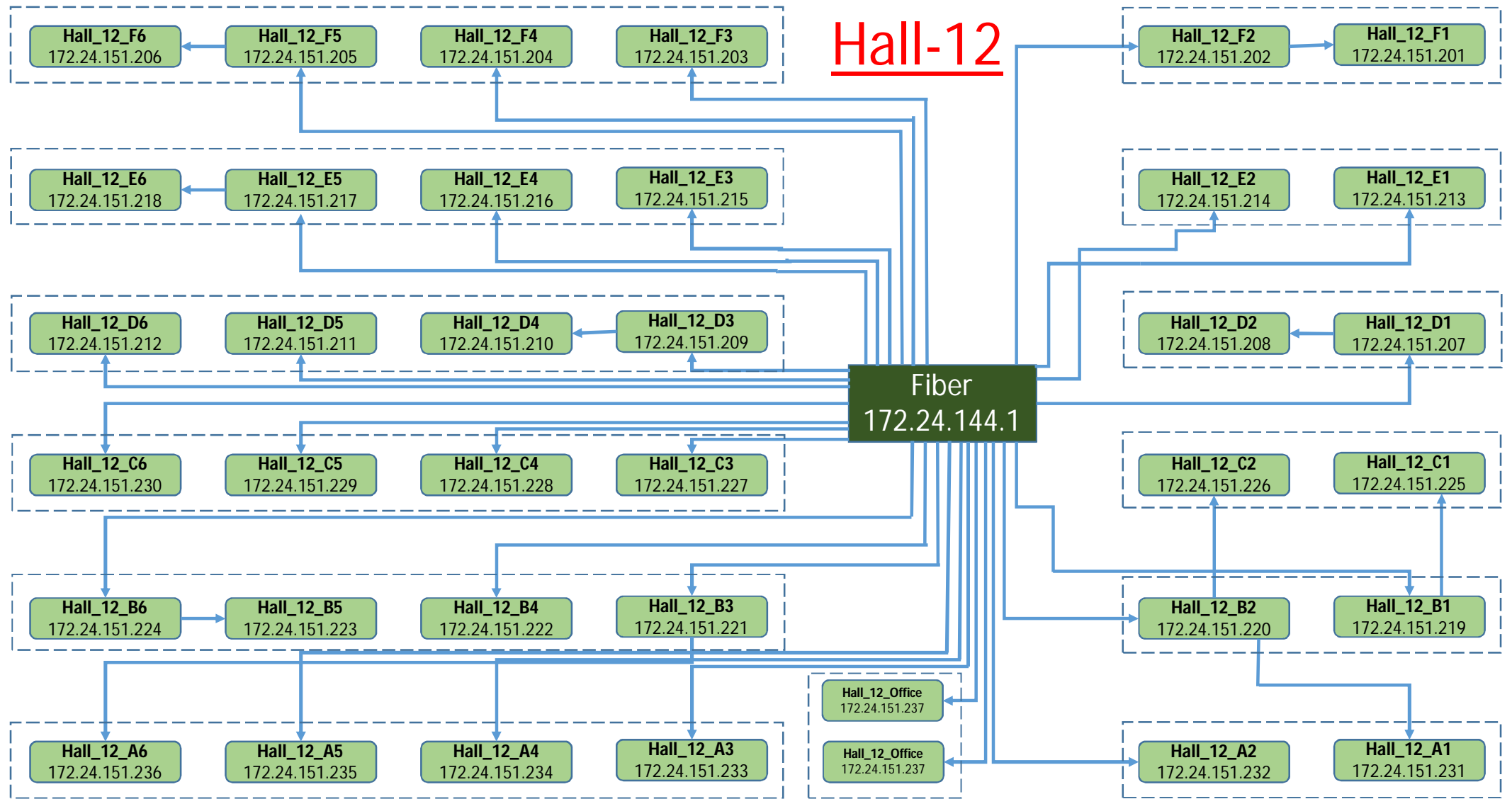

Hall-13

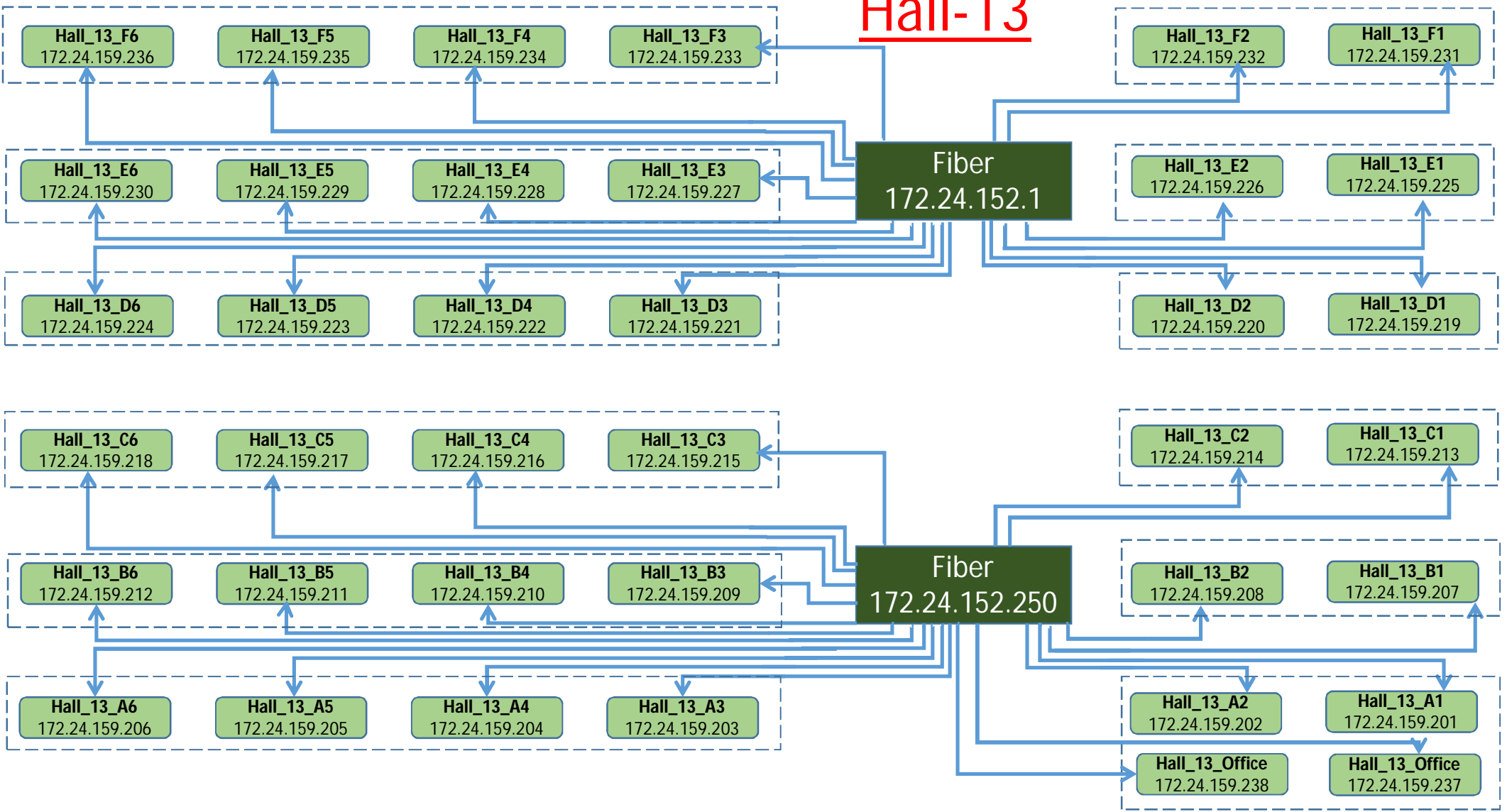

New GH

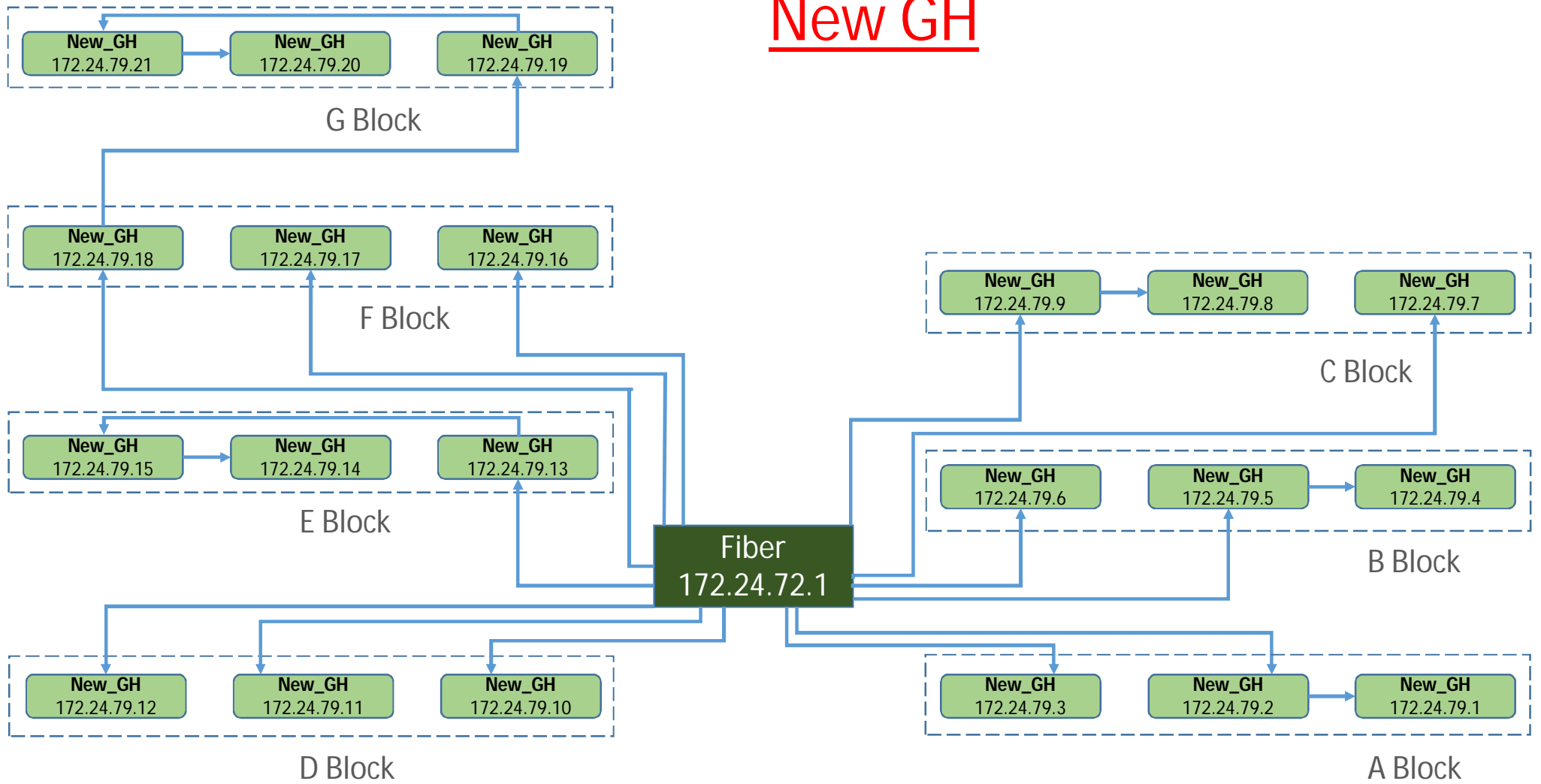

OLD RA

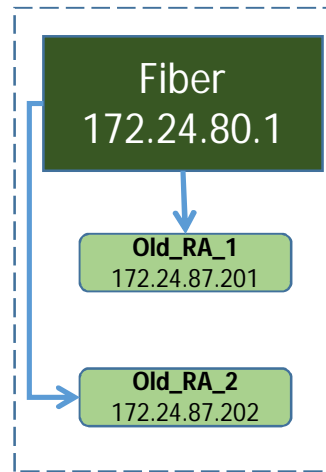

New RAH

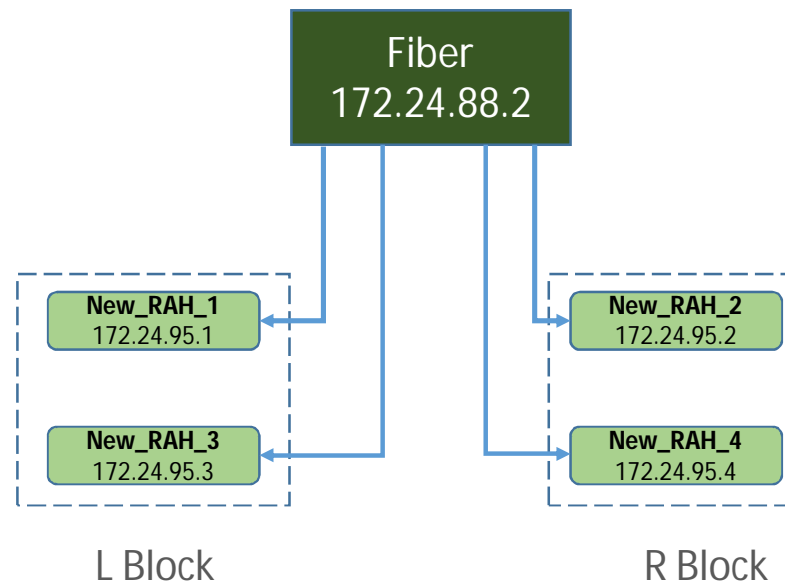

New_RA_Extansion

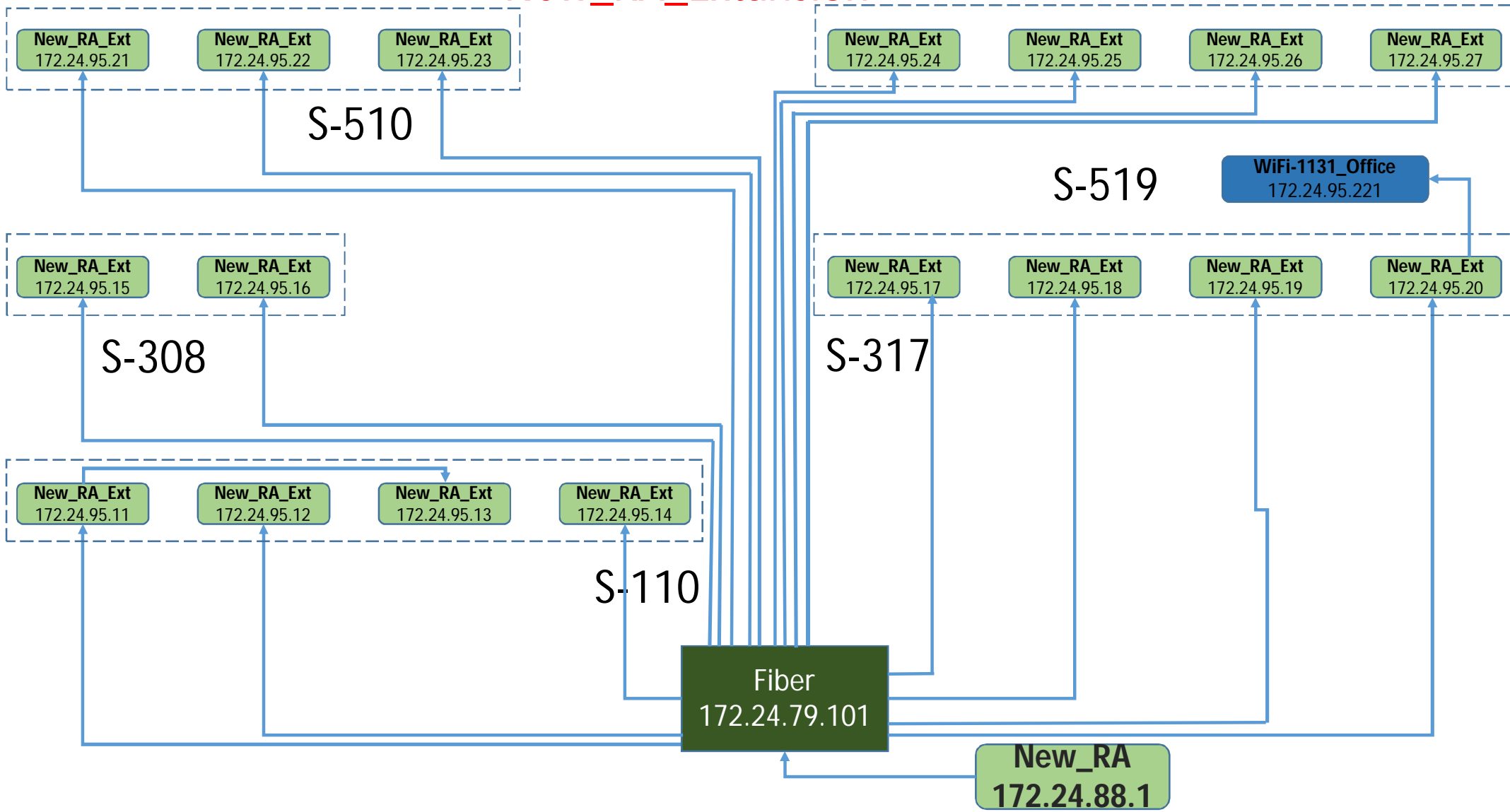

SBRA

